

<b>TEST REPORT</b> <b>DIN V VDE V 0126-1-1:2013.08</b> <b>Automatic disconnecting device</b>	
<b>Report Reference No.</b> .....	200918025GZU-002
Date of issue .....	21 Sep., 2020
Total number of pages.....	28 pages
<b>Testing Laboratory</b> .....	Intertek Testing Services Shenzhen Ltd. Guangzhou Branch
Address .....	Room 02, & 101/E201/E301/E401/E501/E601/E701/E801 of Room 01 1-8/F., No. 7-2. Caipin Road, Science City, GETDD, Guangzhou, Guangdong, China
Testing location/ address .....	Same as above
Tested by (name + signature) .....	Sunny Lin <i>Sunny Lin</i> Engineer
Approved by (+ signature).....	Jason Fu <i>Jason Fu</i> Technical Team Leader
<b>Applicant's name</b> .....	Shenzhen SOFAR SOLAR Co., Ltd.
Address.....	401, Building 4, AnTongDa Industrial Park, District 68, XingDong Community, XinAn Street, BaoAn District, Shenzhen, China
<b>Test specification:</b>	
Standard .....	DIN V VDE V 0126-1-1:2013.08 Enedis-PRO-RES_10E: 2020 (Max(f)=51.5Hz)
Test procedure.....	Type approval for France
Non-standard test method.....	N/A
<b>Test Report Form No.</b> .....	VDE0126-1-1b
Test Report Form(s) Originator .....	Intertek
Master TRF.....	Dated 2013-09
This publication may be reproduced in whole or in part for non-commercial purposes as long as Intertek is acknowledged as copyright owner and source of the material. Intertek takes no responsibility for and will not assume liability for damages resulting from the reader's interpretation of the reproduced material due to its placement and context.	
<b>Test item description</b> .....	Solar Grid-tied Inverter
Trade Mark .....	SOFAR SOLAR
Manufacturer.....	Same as Applicant
Model/Type reference.....	SOFAR 1100TL-G3, SOFAR 1600TL-G3, SOFAR 2200TL-G3 SOFAR 2700TL-G3, SOFAR 3000TL-G3, SOFAR 3300TL-G3

Rating.....:	Model	SOFAR 1100TL-G3	SOFAR 1600TL-G3	SOFAR 2200TL-G3
	Max.PV voltage [Vdc]	500		
	PV voltage range [Vdc]	50-500		
	PV Isc [A]	15		
	Max.input current [A]	12		
	Max.output power [W]	1100	1600	2200
	Max.apparent power [VA]	1100	1600	2200
	Nominal output voltage [Vac]	230		
	Max.output current [A]	5.3	7.7	10.6
	Nominal output Frequency	50Hz		
	Power factor range	0.8Leading – 0.8 lagging		
	Safety level	Class I		
	Ingress Protection	IP 65		
	Operation Ambient Temperature	-30°C - +60°C		
	Model	SOFAR 2700TL-G3	SOFAR 3000TL-G3	SOFAR 3300TL-G3
	Max.PV voltage [Vdc]	550		
	PV voltage range [Vdc]	50-550		
	PV Isc [A]	15		
	Max.input current [A]	12		
	Max.output power [W]	2700	3000	3300
	Max.apparent power [VA]	2700	3000	3300
	Nominal output voltage [Vac]	230		
	Max.output current [A]	13	14.5	16
	Nominal output Frequency	50Hz		

	Power factor range	0.8Leading – 0.8 lagging
	Safety level	Class I
	Ingress Protection	IP 65
	Operation Ambient Temperature	-25°C - +60°C
	Software version	V 1.00

**Summary of testing:**

**Tests performed (name of test and test clause):**

All applicable test items.

**Testing location:**

Room 02, &  
101/E201/E301/E401/E501/E601/E701/E801 of  
Room 01 1-8/F., No. 7-2. Caipin Road, Science City,  
GETDD, Guangzhou, Guangdong, China

**Copy of marking plate(representative):**

The artwork below may be only a draft. The use of certification marks on a product must be authorized by the respective NCBs that own these marks.

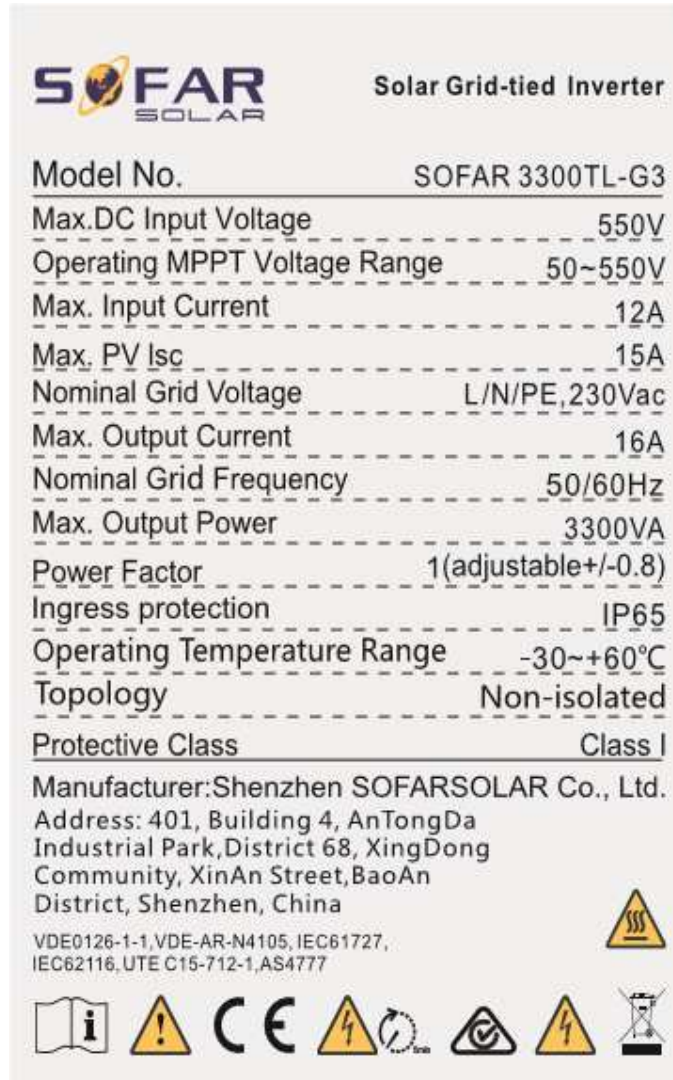

**Note:**

1. The above markings are the minimum requirements required by the safety standard. For the final production samples, the additional markings which do not give rise to misunderstanding may be added.
2. Label is attached on the side surface of enclosure and visible after installation.
3. Other labels are identical to above, except the model name and ratings

<b>Test item particulars</b> .....:	
Temperature range .....	-25°C ~ 60 °C
Overvoltage category .....	<input type="checkbox"/> OVC I <input checked="" type="checkbox"/> OVC II (for PV input) <input checked="" type="checkbox"/> OVC III (for main) <input type="checkbox"/> OVC IV
IP protection class .....	IP65
<b>Possible test case verdicts:</b>	
- test case does not apply to the test object.....	: N/A
- test object does meet the requirement .....	: P (Pass)
- test object does not meet the requirement .....	: F (Fail)
<b>Testing</b> .....:	
Date of receipt of test item.....	: 18 Sep 2020
Date (s) of performance of tests.....	: 18 Sep 2020 to 21 Sep 2020
<b>General remarks:</b>	
<p>The test results presented in this report relate only to the object tested.  This report shall not be reproduced, except in full, without the written approval of the Issuing testing laboratory.  "(see Enclosure #)" refers to additional information appended to the report.  "(see appended table)" refers to a table appended to the report.</p> <p>Throughout this report a point is used as the decimal separator.  Clause numbers in parentheses derive from VDE-AR-N 4105:2011-08.</p> <p>When determining the test conclusion, the Measurement Uncertainty of test has been considered.  This report is for the exclusive use of Intertek's Client and is provided pursuant to the agreement between Intertek and its Client. Intertek's responsibility and liability are limited to the terms and conditions of the agreement. Intertek assumes no liability to any party, other than to the Client in accordance with the agreement, for any loss, expense or damage occasioned by the use of this report. Only the Client is authorized to permit copying or distribution of this report and then only in its entirety. Any use of the Intertek name or one of its marks for the sale or advertisement of the tested material, product or service must first be approved in writing by Intertek. The observations and test results in this report are relevant only to the sample tested. This report by itself does not imply that the material, product, or service is or has ever been under an Intertek certification program.  The test report only allows to be revised only within the report defined retention period unless standard or regulation was withdrawn or invalid.</p> <p><b>This report is based on and superseded original report 19041074GZU-003, dated 31 Oct.,2019, with below modified information:</b>  <b>1.Changed the Max(f)=50.6Hz to Max(f)=51.5Hz</b></p>	

**General product information:**

The unit is a single-phase PV Grid inverter, it can convert the high PV voltage to Grid voltage and feed into Grid network.

The external circuit breakers or fuses for PV array and Grid connection are required which are stated in the installation manual.

The unit is providing EMC filtering at the PV side and AC side. It does not provide galvanic separation from PV side to Grid.

The unit has two controllers. The master controller A monitor the invert statue; measure the PV voltage and current, bus voltage, AC voltage, current, GFCI and frequency, also communicate with the slave controller B

The slave controller B monitor AC voltage, current, frequency , GFCI and communicate with the master controller A

The relays are designed to redundant structure that controlled by separately.

The master controller and slave controller are used together to control relay open or close, if the single fault on one controller, the other controller can be capable to open the relay, so that still providing safety means.

The topology diagram as following:

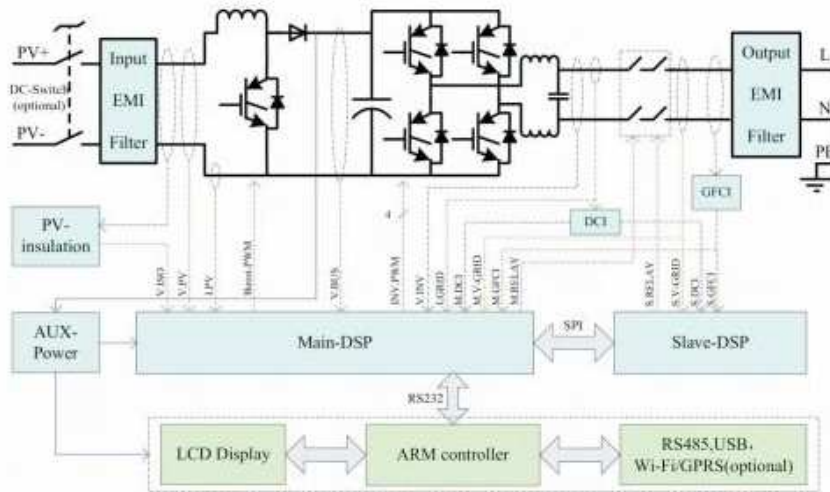

**Models differences:**

The models of SOFAR 1100TL-G3, SOFAR 1600TL-G3, SOFAR 2200TL-G3, SOFAR 2700TL-G3, SOFAR 3000TL-G3 and SOFAR 3300TL-G3 are identical on topological schematic circuit diagram and control solution codes. The difference between each other as following table:

Model	SOFAR 110 0TL-G3	SOFAR 160 0TL-G3	SOFAR 220 0TL-G3	SOFAR 270 0TL-G3	SOFAR 300 0TL-G3	SOFAR 330 0TL-G3
Heatsink size	253*253.3*26.5mm			271*253.3*40mm		
Inverter inductance	0.99mH * 2pcs			0.676mH * 2 pcs		
Bus capacitance	470uF /500V* 2 pcs			470uF/550V * 3 pcs		
Size	303*260.5*118			321*260.5*131.5		

Other than special notes, typical model SOFAR 3300TL-G3 used as representative for testing in this report.

**Factory information:**

Dongguan SOFAR SOLAR Co., Ltd.

1F-6F, Building E, No.1 JinQi Road, Bihu Industrial Park, Wulian Village, Fenggang Town, Dongguan City, China.

DIN V VDE V 0126-1-1:2013.08			
Clause	Requirement - Test	Result - Remark	Verdict
<b>4</b>	<b>REQUIREMENTS</b>		P
4.0	<b>General</b>		P
	<p>These requirements apply to integrated or separate (independent) disconnecting devices unless otherwise noted.</p> <p>The disconnection device has to cut off the power generating system on the ac side from the grid by two switches in series when:</p> <ul style="list-style-type: none"> <li>— the voltage and/or the frequency of the grid is deviating,</li> <li>— direct current (DC) is fed into the Grid.</li> <li>— unintentional islanding operation occurs,</li> <li>— intentional islanding operation using grid backup systems (emergency supplies).</li> </ul>		P
<b>4.1</b>	<b>Functional safety</b>		P
	The safety must be assured under all operating conditions complying with the defined functions 4.3 to 4.6 and – if applicable – 4.8 of the disconnection device. The disconnection device can be an independent unit or an integrated part of the power generating unit and must switch off in case of a fault and indicate the fault status	Considered, see Annex. The single fault safe system was reviewed. The theoretical investigation was verified by error simulation.	P
<b>4.1.1</b>	<b>Single fault tolerance</b>		P
	The disconnection device must comply with the single fault tolerance requirements of VDE-AR-N 4105:2011-08, A.6	Considered, functional explanation and table 6.1 below.	P
<b>4.1.2</b>	<b>Interface Switch</b>		P
	The interface switch must, in case it is integrated into a PV-inverter, comply with the requirements of DIN EN 62109-2(VDE 0126-14-2):2012-04, 4.4.4.15.2 and in all other cases with the requirements according to VDE-AR-N 4105:2011-08, 6.4.	Disconnection takes place redundant through two relays and the IGBT-full bridge in series. The relays and the IGBT-full bridge are able to switch the full current.	P
<b>(6.4.1)</b>	<b>General</b>		P
	<p>For the connection of the power generation system to the network operator's low-voltage network or to the remaining customer system, it is necessary to use an interface switch. It consists of two electric switching devices connected in series and shall thus be constructed redundantly. The interface switch is controlled by the NS protection and activates automatically if at least one protective function responds.</p> <p>The breaking devices of the interface switch shall be designed to be short-circuit proof and shall be</p>		P



DIN V VDE V 0126-1-1:2013.08			
Clause	Requirement - Test	Result - Remark	Verdict
	<p>releasable without delay and with due regard to the protective devices required by clause 6.5. The breaking capacity of the two breaking devices of the interface switch shall be dimensioned at least in accordance with the responding range of the upstream safety fuse or the maximum short-circuit current contribution of the power generation system.</p> <p>Switches with at least breaking capacity shall be use for both breaking devices of the interface switch. In addition to that, all-pole disconnection shall be ensured.</p>		
<b>(6.4.2)</b>	<b>Central interface switch</b>		N/A
	<p>The two break devices of the central interface switch shall be executed as galvanic break devices.</p> <p>The two break devices of the interface switch shall be installed directly at the central meter panel in the circuit distributor of the power generation system.</p>		N/A
<b>(6.4.3)</b>	<b>Integrated interface switch</b>		P
	<p>Construction of the interface switch shall be carried out taking into consideration the single-fault tolerance.</p> <p>An interface switch ensures a single-fault tolerant all-phase galvanic breaking.</p> <p>For power generation systems with inverters, the interface switch shall be provided on the inverter's network side. A short circuit in the inverter shall not impair the switching function of the interface switch.</p>		P
<b>4.2</b>	<b>Connection conditions</b>		P
	<p>The connection, the reconnection after a grid-fault and the reconnection after short interruption shall be carried out according to VDE-AR-N 4105:2011-08, 8.3.1</p>		P
<b>(8.3.1)</b>	<b>General</b>		P
	<p>A power generation system shall be connected to the network operator's network only if a suitable device determines that both the mains voltage and the mains frequency are within the tolerance range of 85 % Un to 110 % Un or 47.5 Hz to 50.05 Hz, respectively, for a period of at least 60 seconds.</p> <p>If decoupling protection devices are tripped because of a short interruption, then the power generation system is permitted to already reconnect as soon as the mains voltage and mains frequency have uninterruptedly remained within the tolerance ranges given above for a period of 5 seconds. Short time interruptions are characterised by the NS protection settings of the mains frequency and/ or network voltage being exceeded or undershot for a maximum period of 3 seconds.</p> <p>The power generation system being reconnected to the</p>	<p>Tested with a variable AC-Power supply at the output. Inverter disconnects within the limits, see table 6.2 below.</p>	P

DIN V VDE V 0126-1-1:2013.08			
Clause	Requirement - Test	Result - Remark	Verdict
	network operator's network at the tripping of the decoupling protection device, the active power of controllable power generation systems supplied to the network operator's network shall not exceed the gradient of 10 % of the active power per minute.		
<b>4.3</b>	<b>Monitoring the voltage</b>		P
<b>4.3.1</b>	<b>voltage drop <math>U&lt;</math></b>		P
	The disconnection because of a voltage drop shall be carried out according to VDE-AR-N 4105:2011-08, 6.5.1 and 6.5.2	See appended table below.	P
<b>4.3.2</b>	<b>rise-in-voltage <math>U&gt;&gt;</math></b>		P
	The disconnection because of a rise-in-voltage shall be carried out according to VDE-AR-N 4105:2011-08, 6.5.1 and 6.5.2	See appended table below.	P
<b>4.3.3</b>	<b>slow rise-in-voltage <math>U&gt;</math></b>		P
	The disconnection because of a slow rise-in-voltage (10-minute-average) shall be carried out according to VDE-AR-N 4105:2011-08, 6.5.1 and 6.5.2	See appended table below.	P
<b>4.4</b>	<b>Monitoring the frequency</b>		P
	The disconnection because of a frequency decrease or a frequency increase shall be carried out according to VDE-AR-N 4105:2011-08, 6.5.1 and 6.5.2	See appended table below.	P
<b>(6.5.1)</b>	<b>General</b>		P
	<p>The purpose of the NS protection is to disconnect the power generation system from the net in the event of inadmissible voltage and frequency values. This is intended to prevent an unintentional feed-in of the power generation system into a power-supply unit separated from the remaining distribution network as well as the feed-in of faults within this network.</p> <p>The system operator shall himself take precautions to prevent damages to his systems and installations as might be caused by switching actions, voltage fluctuations and automatic reclosings in the network connected upstream or other process in the network of the network operator.</p> <p>The following functions of the decoupling protection shall be implemented:</p> <ul style="list-style-type: none"> <li>- Voltage drop protection <math>U&lt;</math>;</li> <li>- Rise-in-voltage protection <math>U&gt;</math>;</li> <li>- Rise-in-voltage protection <math>U&gt;&gt;</math>;</li> <li>- Frequency decrease protection <math>f&lt;</math>;</li> <li>- Frequency increase protection <math>f&gt;</math>;</li> <li>- Islanding detection.</li> </ul>		P

DIN V VDE V 0126-1-1:2013.08			
Clause	Requirement - Test	Result - Remark	Verdict
	The setting values of the protective functions and the last five dated failure reports shall be readable at the NS protection. Interruptions of supply with durations of 3 s or longer shall not lead to loss of any of the failure reports. Read-out shall be possible at the central NS protection irrespective of the operational state of the power generation system and without any additional aids. For integrated NS protection read-out may be carried out using a data interface.		
<b>(6.5.2)</b>	<b>Protective functions</b>		P
	The protective functions of the NS protection shall be designed so that the disconnection time (the sum of the proper times of NS protection and interface switch plus a delay for the protection relay, which may or may not be adjustable) does not exceed 200 ms.		P
<b>4.5</b>	<b>Monitoring the dc current</b>		P
	A feed in of d.c current into the low-voltage grid due to defective equipment must lead to a switch off within 0.2 seconds. For this purpose the fault itself or a measurement of the dc component of the current exceeding 1 A can be used as disconnection criteria.	See appended table below.	P
<b>4.6</b>	<b>Detection of islanding operation</b>		P
	The disconnection because of a detection of unintended islanding operation shall be carried out according to VDE-AR-N 4105:2011-08, 6.5.1 and 6.5.3	See appended table below.	P
<b>(6.5.3)</b>	<b>Islanding detection</b>		P
	The islanding detection is implemented in the central NS protection or in the integrated NS protection of the power generation unit. If an islanding detection system acting on the integrated interface switch is integrated in all power generation units of a power generation system, then it is permitted to omit the islanding detection in the central NS protection regardless of the system power.  Detection of an isolated network and disconnection of the power generation system by means of the interface switch shall be completed within 5 seconds.	See appended table below.	P
<b>4.7</b>	<b>Markings</b>		P
	A generating system equipped with an automatic disconnecting device shall be marked with the information "VDE 0126-1-1" which is visible from the outside. This can be done by <ul style="list-style-type: none"> <li>— the marking plate or</li> <li>— showing it on a display of the disconnection device or</li> </ul>		P

DIN V VDE V 0126-1-1:2013.08			
Clause	Requirement - Test	Result - Remark	Verdict
	— a separate marking		
<b>4.8</b>	<b>Requirements for disconnection devices integrated into PV-inverters</b>		P
	The requirements of the DIN EN 62109-2 (VDE 0126-14-2):2012-04, 4.8 regarding the residual current detection and the insulation detection of the PV-generator shall be complied with.		P
<b>5</b>	<b>General Requirements</b>		P
	Limits according to DIN EN 61000-6-3 (VDE 0839-6-3) regarding radio interferences must be complied with. For disturbance-free operation disturbance limits according to DIN EN 61000-6-2 (VDE 0839-6-2) shall be complied with.		P
<b>6</b>	<b>TYPE TESTING</b>		<b>P</b>
<b>6.0</b>	<b>General</b>		P
	The following tests are valid for integrated and separated disconnecting devices unless otherwise noted. A separate disconnection device must be tested together with a suitable supply. It has to be ensured that the turn-off signal is caused by the disconnection device and not by the supply.	See following of test report	P
<b>6.1</b>	<b>Functional safety</b>		P
	The testing of the single fault tolerance and the error detection with following disconnection according to 4.1 is carried out according to DIN VDE V 0124-100 (VDE V 0124-100):2012-07, 5.4.5.2.		P
<b>6.2</b>	<b>Connection conditions</b>		P
	The testing of the connection and the reconnection is carried out according to DIN VDE V 0124-100 (VDE V 0124-100):2012-07, 5.5.1 and 5.5.2.		P
<b>6.3</b>	<b>Monitoring the voltage</b>		P
	The testing of the voltage monitoring is carried out according to DIN VDE V 0124-100 (VDE V 0124-100):2012-07, 5.4.5.3.		P
<b>6.4</b>	<b>Monitoring the frequency</b>		P
	The testing of the frequency monitoring is carried out according to DIN VDE V 0124-100 (VDE V 0124-100):2012-07, 5.4.5.4.		P
<b>6.5</b>	<b>Monitoring the dc current</b>		P

DIN V VDE V 0126-1-1:2013.08			
Clause	Requirement - Test	Result - Remark	Verdict
	<p>The testing of the disconnection due to feed in of direct current is carried out either by a) or b):</p> <p>a) The measuring device at the switching point (e.g. current transformer or resistance) is fed with direct current of 1 A. The cut-off must be carried out within 0.2 seconds.</p> <p>b) By means of a fault simulation it is measured if a defective system operation with a d.c. fault current of more than 1 A leads to cut-off within 0.2 seconds.</p>		P
<b>6.6</b>	<b>Detection of islanding operation</b>		P
	The testing of the disconnection due to unintended islanding operation is carried out according to DIN VDE V 0124-100 (VDE V 0124-100):2012-07, 5.4.6.		P
<b>7</b>	<b>Routine Test</b>		<b>P</b>
	The manufacturer has to carry out routine tests regarding all safety relevant functions before delivering an automatic disconnection device.		P
<b>8</b>	<b>Construction Specification</b>		<b>P</b>
	Initial tests and re-examination in addition to the routine tests may be omitted. If the disconnection device is a separate unit it must not be used in a TN-C power system. In this case a TN-C-S power system must be created.		P

<b>6.1</b> <b>(5.4.5.1 &amp; 5.4.5.2)</b>	<b>TABLE: General requirements</b>	<b>P</b>
--	------------------------------------	----------

Design of functional safety:

The unit has two controllers. The master controller A monitor the invert statue; measure the PV voltage and current, bus voltage, AC voltage, current, GFCI and frequency, also communicate with the slave controller B

The slave controller B monitor AC voltage, current, frequency, GFCI and communicate with the master controller A

The relays are designed to redundant structure that controlled by separately.

The master controller and slave controller are used together to control relay open or close, if the single fault on one controller, the other controller can be capable to open the relay, so that still providing safety means.

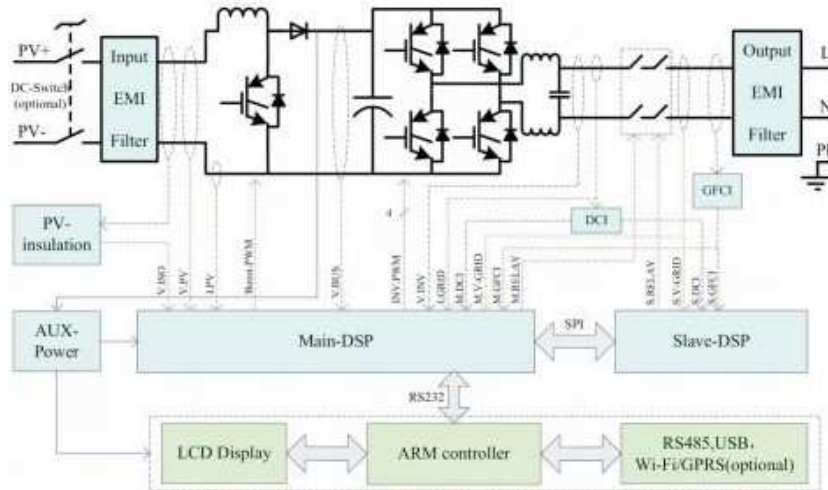

<b>6.1 (6.5.1)</b>	<b>TABLE: General requirements</b>						
--------------------	------------------------------------	--	--	--	--	--	--

String	1	U <sub>DC</sub> = U <sub>n</sub>	500Vdc	U <sub>ac</sub> = U <sub>n</sub>	230 Vac	P = (W)	3300
Component No.	Fault		Observation				
Relay defect RY3 (4-3pin)	S-C before start up		PV inverter does not start up and connected to grid. No damaged, no hazard.				
Relay defect RY2 (4-3pin)	S-C before start up		PV inverter does not start up and connected to grid. No damaged, no hazard.				
Relay defect RY4 (4-3pin)	S-C before start up		PV inverter does not start up and connected to grid. No damaged, no hazard.				
Relay defect RY5 (4-3pin)	S-C before start up		PV inverter does not start up and connected to grid. No damaged, no hazard.				

AC current monitoring defect RP85	O-C	PV inverter disconnected from grid immediately. No damaged, no hazard.
AC voltage monitoring defect R88	O-C	PCE protected immediately. Report ID01, No damaged. No hazard.
ECP63	S-C	PCE protected immediately. Disconnect from the grid. After fault removed, it can be work normally. No damaged. No hazard.
U13 Pin 8	O-C	PCE protected immediately. Disconnect from the grid. After fault removed, it can be work normally. No damaged. No hazard.
XL2 Pin1-3	S-C	PV inverter disconnected from grid immediately. No damaged, no hazard.
U5 Pin2-3	S-C	PCE protected immediately. Report ID05, No damaged. No hazard.
RC62	S-C	PCE protected immediately. Report ID20, No damaged. No hazard.
CC76	S-C	PCE protected immediately. Report ID20, No damaged. No hazard.
U1 Pin2-3	S-C	PCE protected immediately. Report ID02, No damaged. No hazard.
U1 Pin5-6	S-C	PCE protected immediately. Report ID55, No damaged. No hazard.
U6 Pin2-3	S-C	PCE protected immediately. Report ID23, No damaged. No hazard.
UC3 Pin5-6	S-C	PCE protected immediately. Report ID17,ID18, No damaged. No hazard.
XLC1 Pin 1-3	S-C	PCE protected immediately. No damaged. No hazard.
<p>Supplementary information: S-C: Short circuit, O-C: Open circuit</p> <p>During the test: Fire do not propagates beyond the EUT; Equipment do not emit molten metal; Enclosures do not deform to cause non-compliance with the standard. Pass the dielectric test.</p>		

6.2 (5.5.1)	Connection conditions		P
DC input:	AC output:	Rated Output Power	
360Vdc	230Vac; 50Hz	3300W	
Measure Item	Reconnection?		Reconnection Time (>60s)
$f_{ist} = 47,45\text{Hz}$	<input type="checkbox"/> Yes	<input checked="" type="checkbox"/> No	Cannot reconnection
$f_{ist} \geq 47,55\text{Hz}$	<input checked="" type="checkbox"/> Yes	<input type="checkbox"/> No	81.2s
$f_{ist} > 50,1\text{Hz}$	<input type="checkbox"/> Yes	<input checked="" type="checkbox"/> No	Cannot reconnection
$f_{ist} \leq 50,1\text{Hz}$	<input checked="" type="checkbox"/> Yes	<input type="checkbox"/> No	82.0s
$U_{ist} < 85\% U_n$	<input type="checkbox"/> Yes	<input checked="" type="checkbox"/> No	Cannot reconnection
$U_{ist} \geq 85\% U_n$	<input checked="" type="checkbox"/> Yes	<input type="checkbox"/> No	81.0s
$U_{ist} > 110\% U_n$	<input type="checkbox"/> Yes	<input checked="" type="checkbox"/> No	Cannot reconnection
$U_{ist} \leq 110\% U_n$	<input checked="" type="checkbox"/> Yes	<input type="checkbox"/> No	81.8s

Graph of the gradual power supply and reconnection: for 47.55Hz

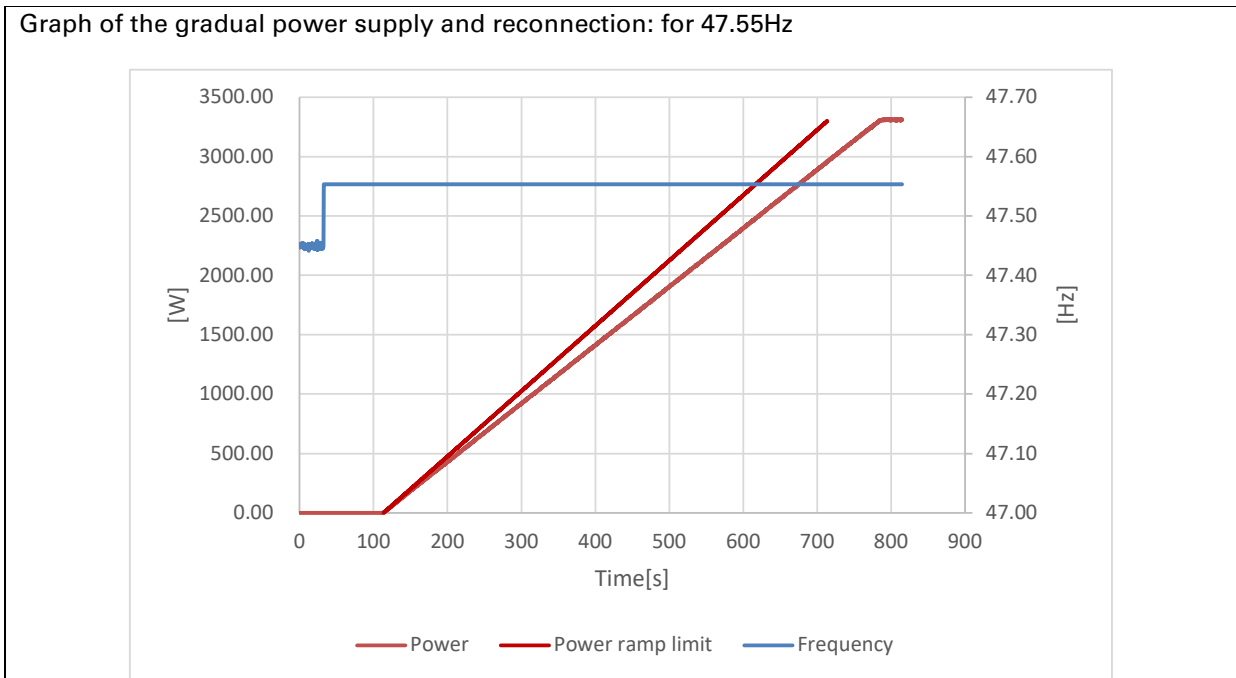



Graph of the gradual power supply and reconnection: for 50.1Hz

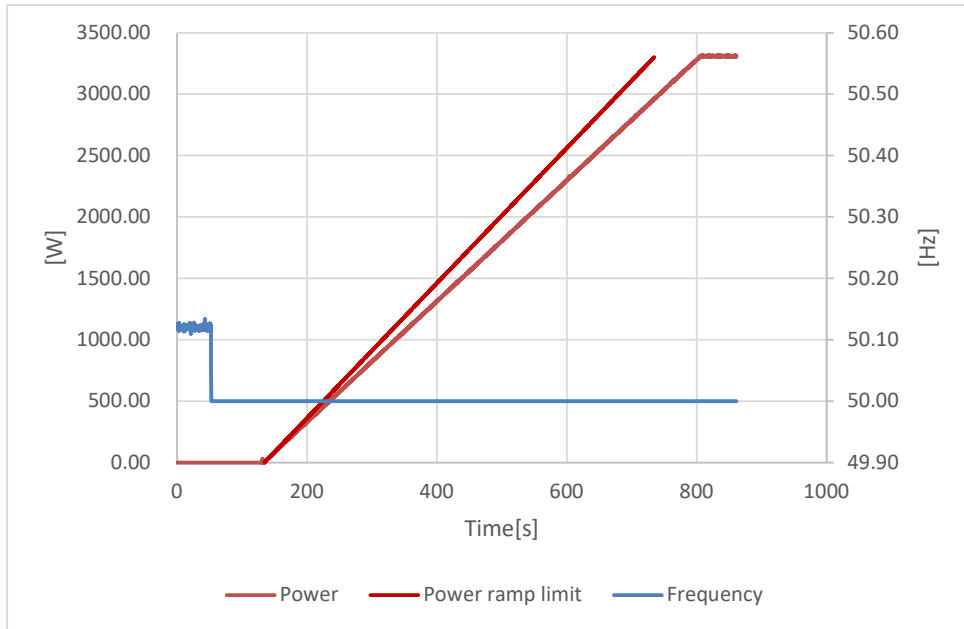

Graph of the gradual power supply and reconnection: for 85%Un

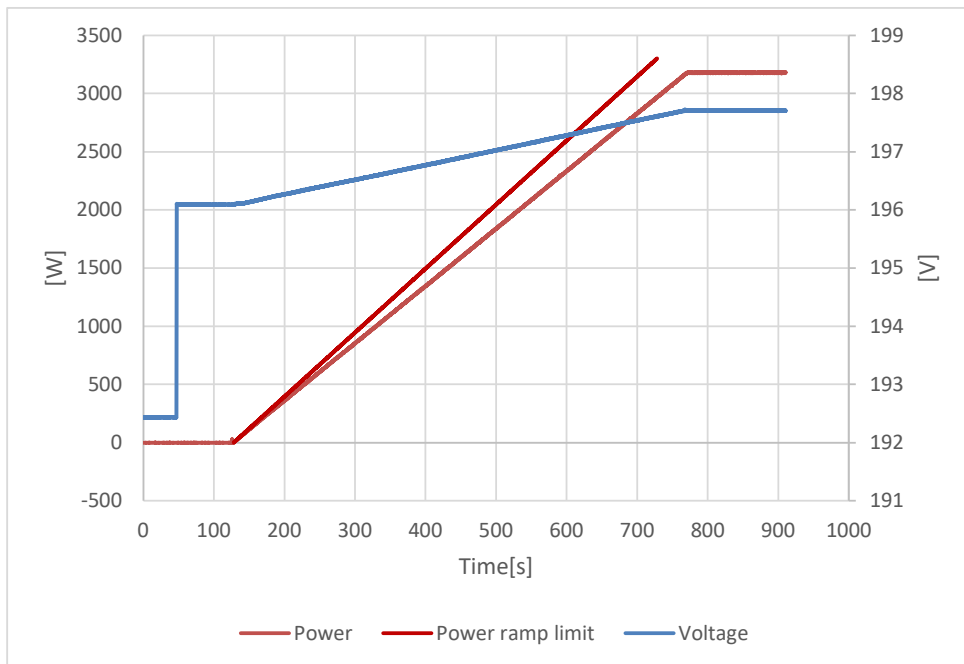

Graph of the gradual power supply and reconnection: for 110%Un

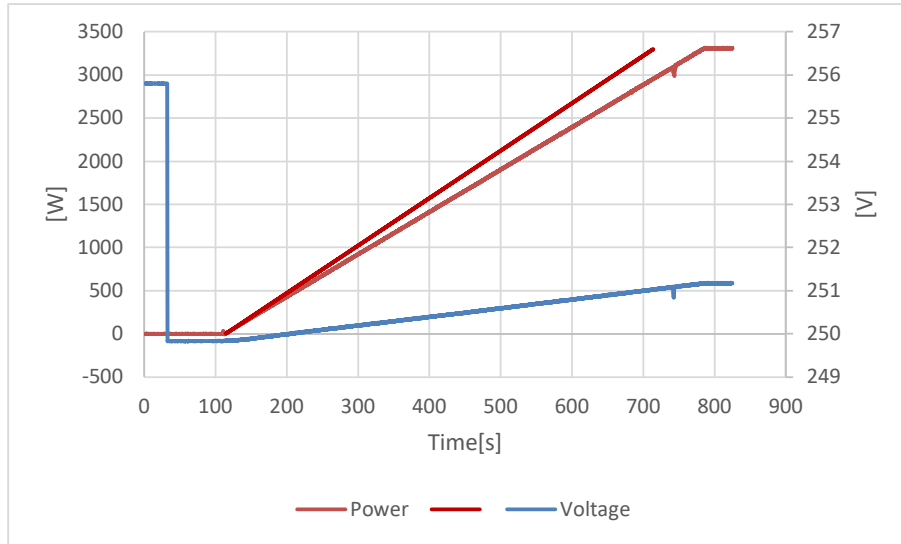

6.2 (5.5.2)	Short-time Interruption									P
	1			2			3			
	U <sub>n</sub> (V)	Repeated Time (s)	Gradient (W/min)	U <sub>n</sub> (V)	Repeated Time (s)	Gradient (W/min)	U <sub>n</sub> (V)	Repeated Time (s)	Gradient (W/min)	
After 2s of 77% U <sub>n</sub>	230	44.0	289.98	230	47.4	89.20	230	45.6	289.23	
After 4s of 77% U <sub>n</sub>	230	81.1	290.69	230	81.4	291.01	230	81.8	290.01	

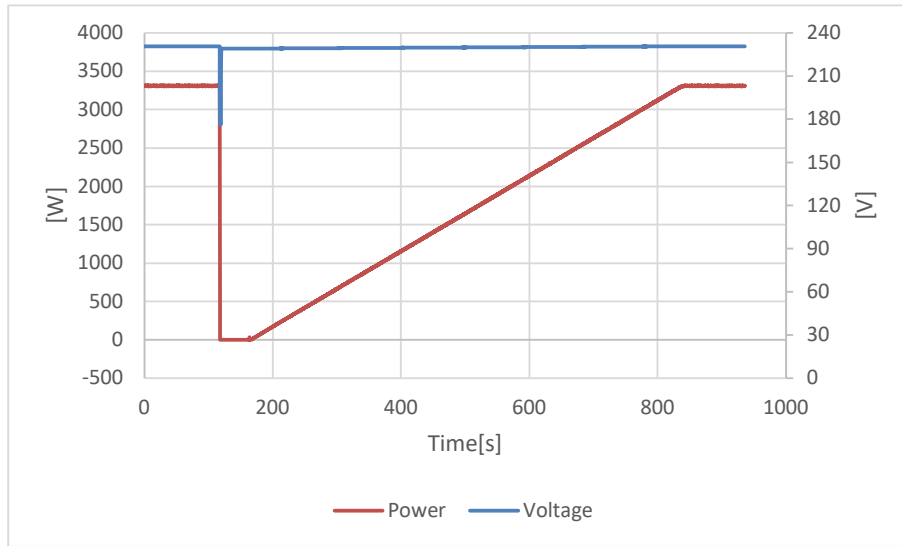

After 2s of 77% U<sub>n</sub>

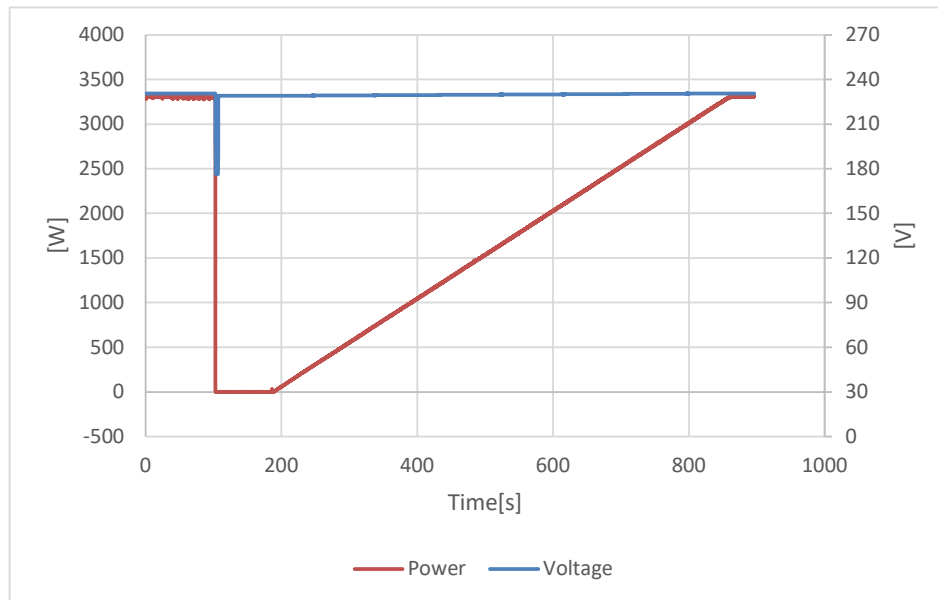

After 4s of 77% U<sub>n</sub>

6.3 (5.4.5.3)	Monitoring the voltage (Results of Voltage monitoring)						P
Rated Voltage (Un)	230Vac		Rated Frequency		50Hz		
	1		2		3		
Un to 118% Un	264.70V	58.0	264.51V	68.0	264.56V	70.0	
Un to 77% Un	184.31V	61.0	184.20V	59.0	184.57V	58.0	

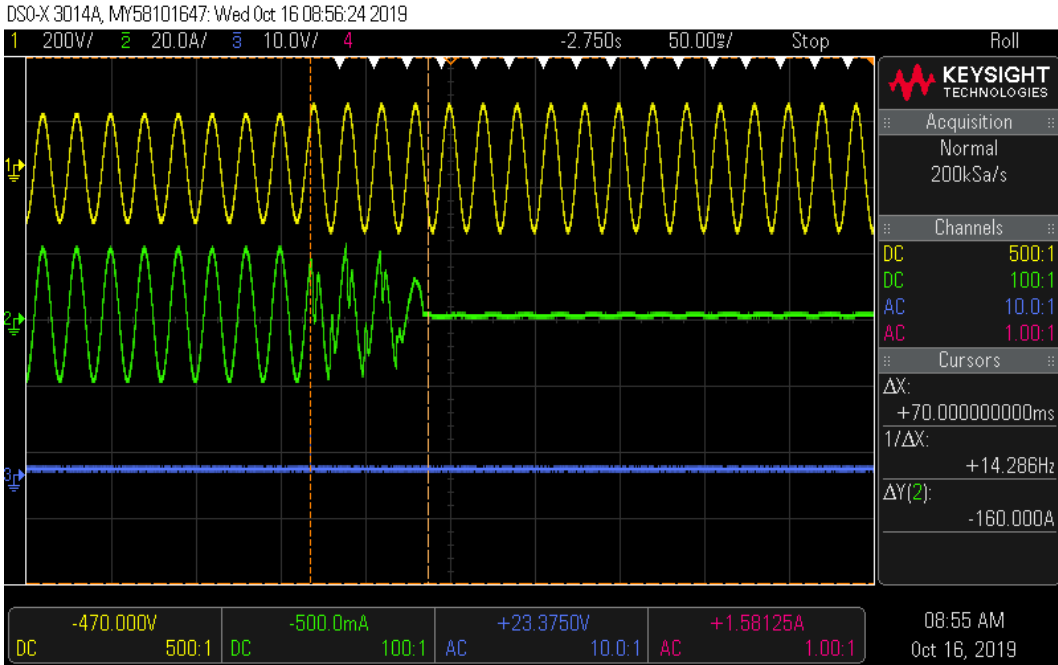

Un to 118% Un

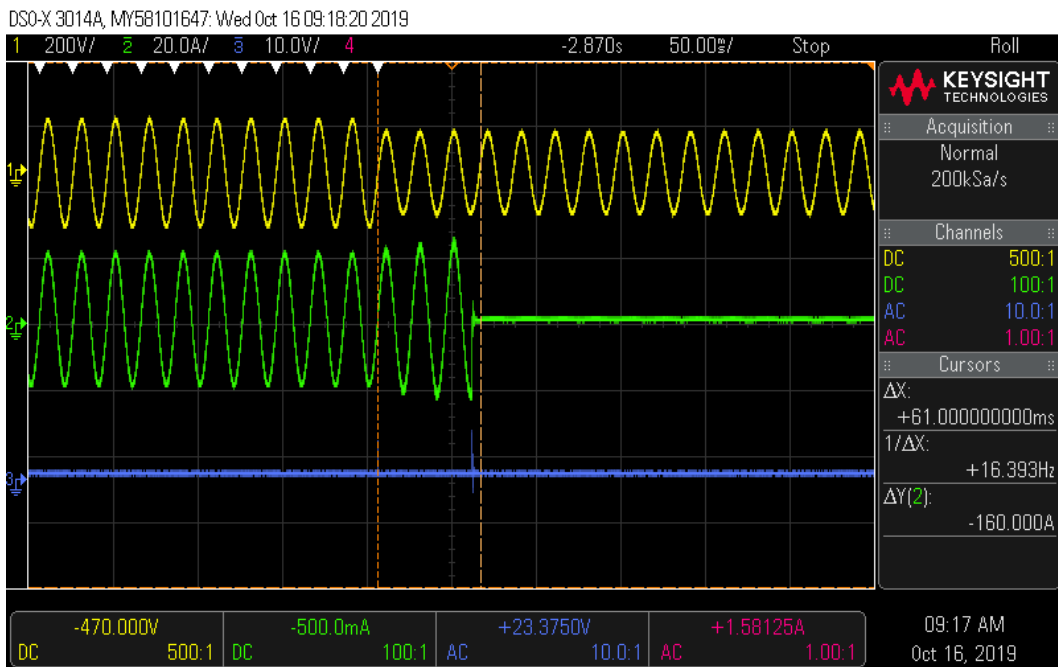

77% Un

CH1 denotes Voltage of output, CH2 denotes current of output, CH3 denotes trip signal

6.3 (5.4.5.3)	Monitoring the voltage (Results of the Protection of the Increase in Voltage as 10-min moving average)		P
	Output Voltage (V)	Switch	
		On/Off state Finally	Time until Switch off (s)
100% Un	230.0	<input checked="" type="checkbox"/> On <input type="checkbox"/> Off	Work normally
112% Un	257.6	<input type="checkbox"/> On <input checked="" type="checkbox"/> Off	502.5s
100% Un	230.0	<input checked="" type="checkbox"/> On <input type="checkbox"/> Off	Work normally
108% Un	248.4	<input checked="" type="checkbox"/> On <input type="checkbox"/> Off	Work normally
106% Un	243.8	<input checked="" type="checkbox"/> On <input type="checkbox"/> Off	Work normally
114% Un	262.2	<input type="checkbox"/> On <input checked="" type="checkbox"/> Off	297.0s

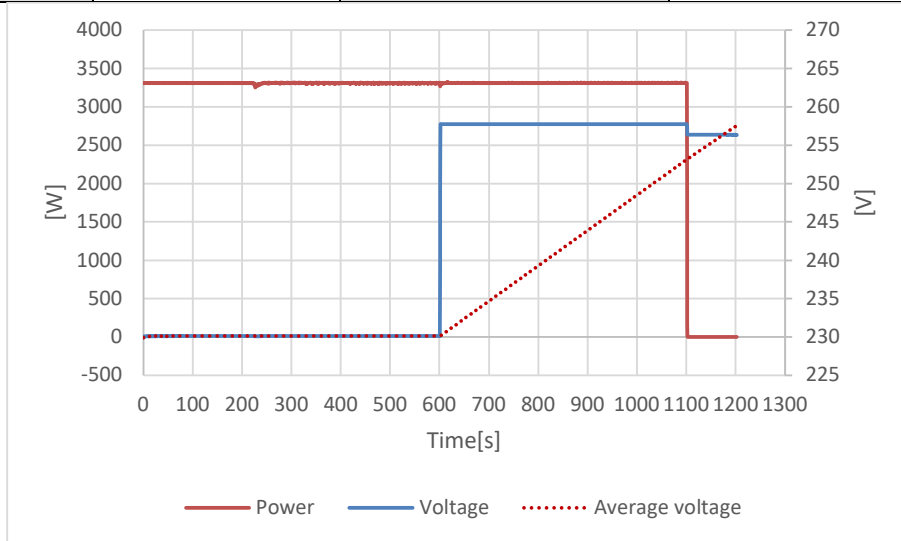

112% Un

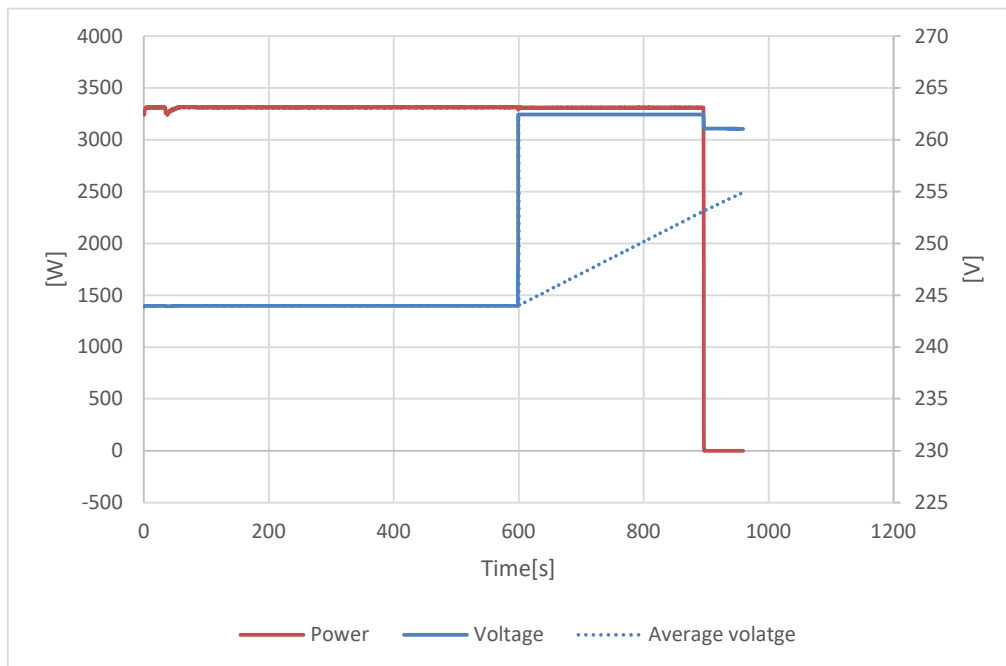

114% Un

6.4 (5.4.5.4)	Monitoring the frequency						P
	1		2		3		
	f (Hz)	Trip time (ms)	f (Hz)	Trip time (ms)	f (Hz)	Trip time (ms)	
Frequency decrease	47.50	80.0	47.50	97.0	47.50	73.0	
Frequency increase	51.52	70.0	51.52	72.0	51.52	78.0	

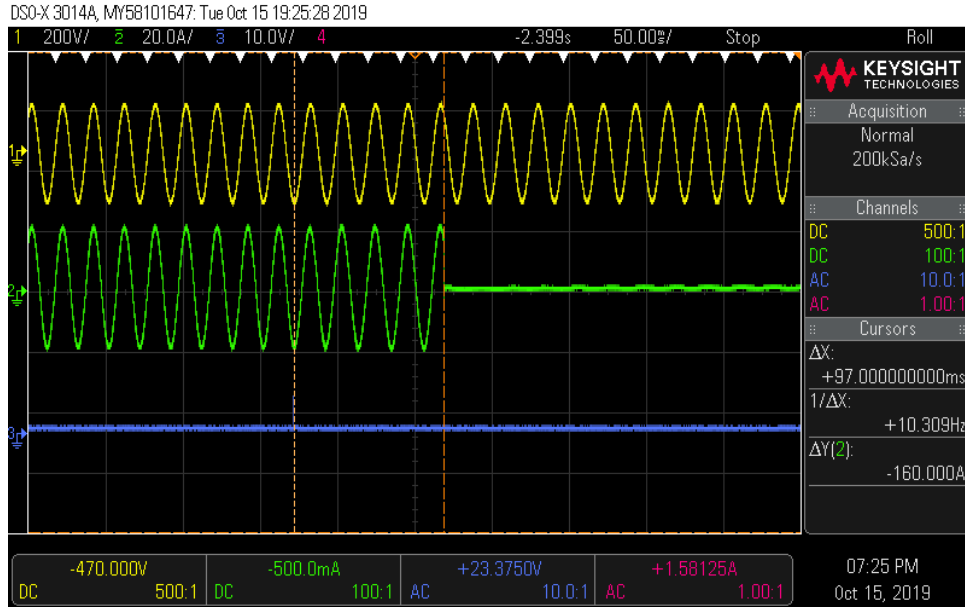

Frequency decrease

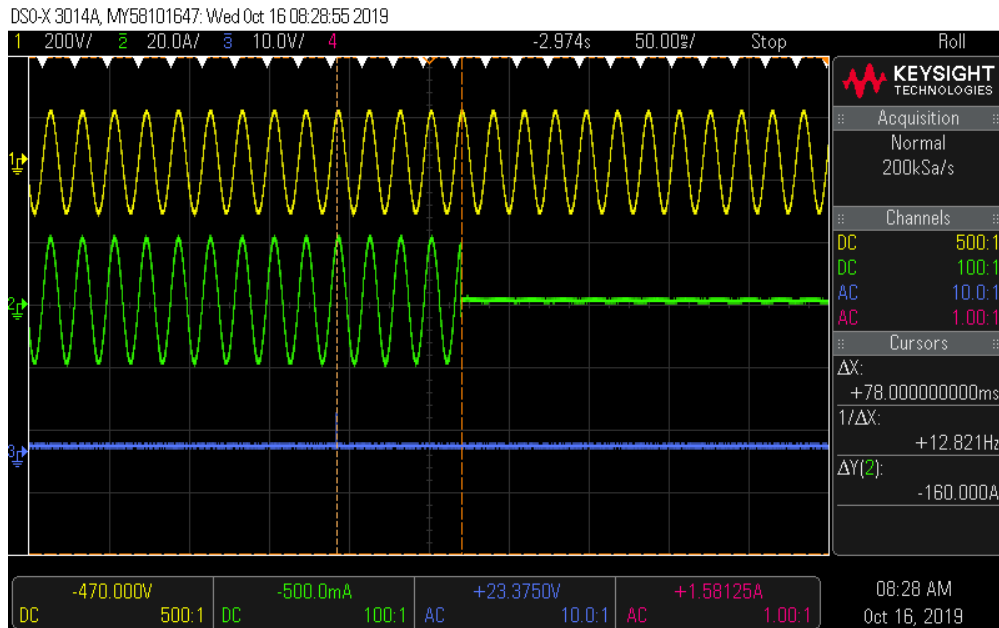

Frequency increase

CH1 denotes Voltage of output, CH2 denotes current of output, CH3 denotes trip signal.

6.5	TABLE: Monitoring the dc current	P
P = 0.25 P <sub>N</sub> = (W)		825W
Feed-in current = 1.0 A d.c., Cut-off current = (ms)		159.0
P = 0.5 P <sub>N</sub> = (W)		1650W
Feed-in current = 1.0 A d.c., Cut-off current = (ms)		156.4
P = 1.0 P <sub>N</sub> = (W)		3300W
Feed-in current = 1.0 A d.c., Cut-off current = (ms)		116.4

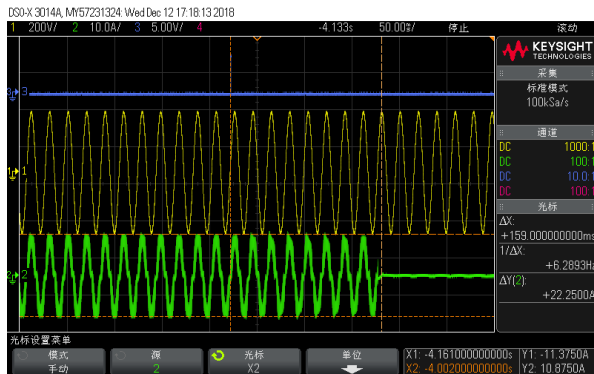

Feed-in current at 25%P

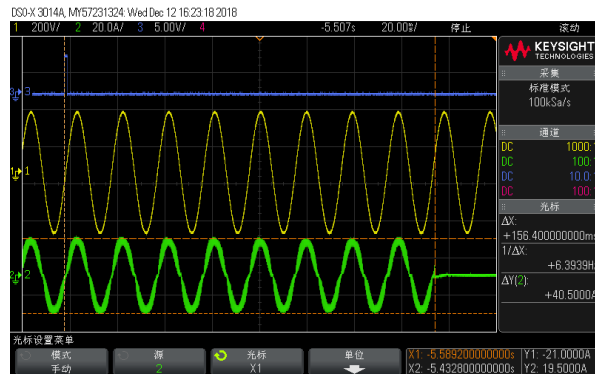

Feed-in current at 50%P

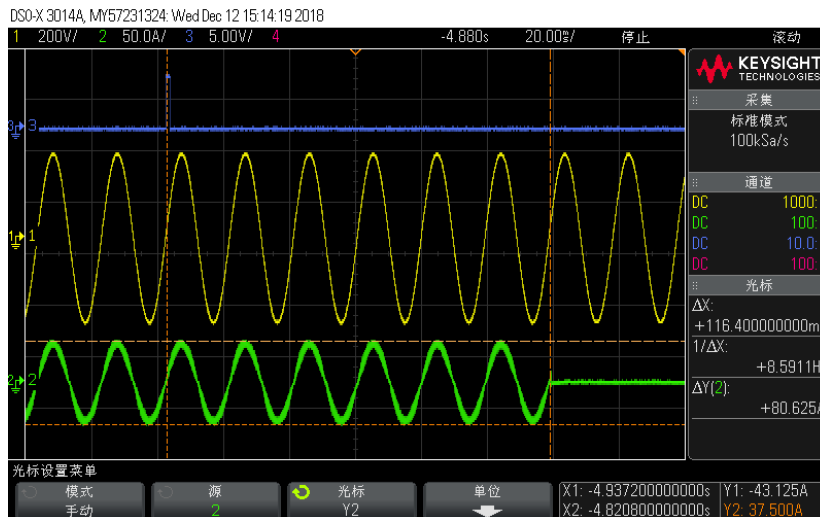

Feed-in current at 100%P

Color Yellow denotes Voltage of output, Green denotes current of output, Blue denotes trip signal.

**Appendix Photos**

6.6 (5.4.6)	TABLE: Detection of islanding operation				P
Test conditions:		Frequency: 50+/-0,2Hz UN=230+/-3Vac RLC consumes inverter real power within +/-3% Distortion factor of chokes <3% Quality Q>2			
P = 1.0 P <sub>N</sub> = (W)	3300W	P = 0.5 P <sub>N</sub> = (W)	1650W	P = 0.25 P <sub>N</sub> = (W)	825W
Q <sub>L</sub> = 6.648KVar	Cut-off time (ms)	Q <sub>L</sub> = 3.303KVar	Cut-off time (ms)	Q <sub>L</sub> = 1.653KVar	Cut-off time (ms)
95%	320	95%	366	95%	338
96%	336	96%	358	96%	308
97%	338	97%	328	97%	314
98%	336	98%	320	98%	328
99%	392	99%	334	99%	374
100%	406	100%	354	100%	422
101%	344	101%	430	101%	330
102%	350	102%	370	102%	320
103%	348	103%	388	103%	360
104%	352	104%	330	104%	342
105%	232	105%	352	105%	316



**Appendix Photos**

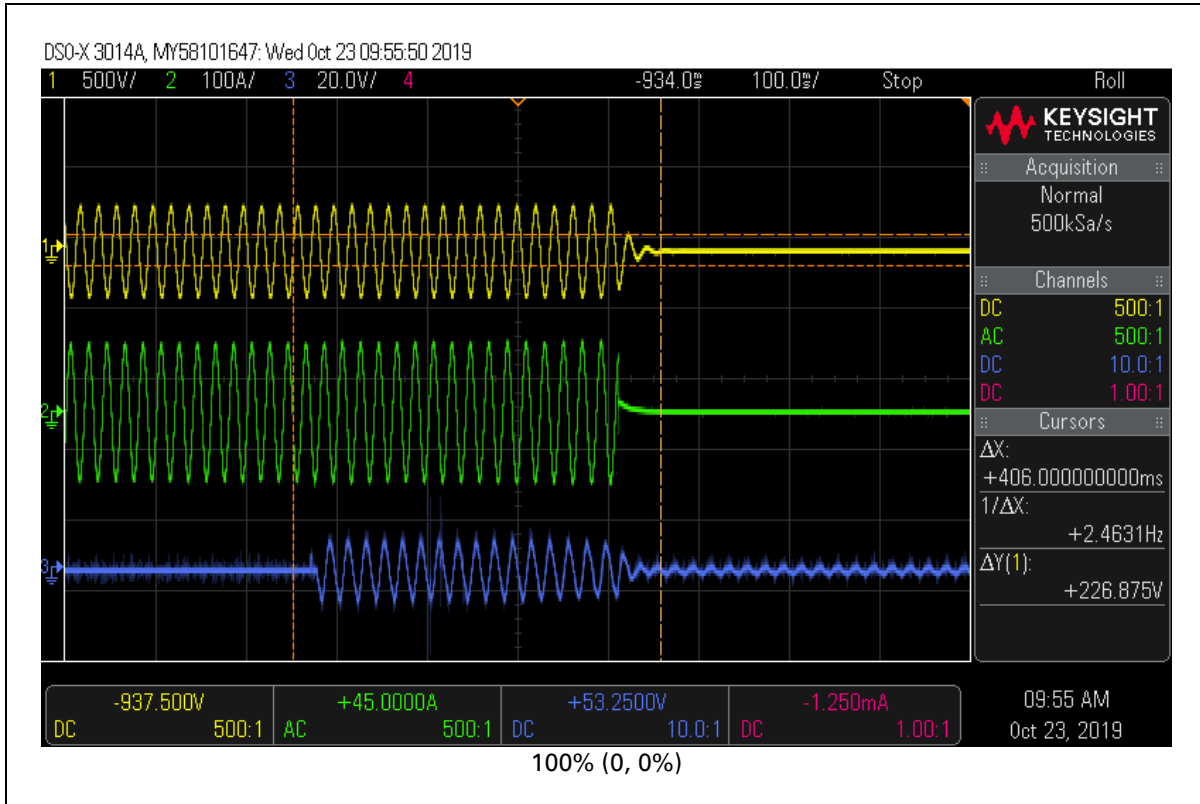

**Appendix Photos**

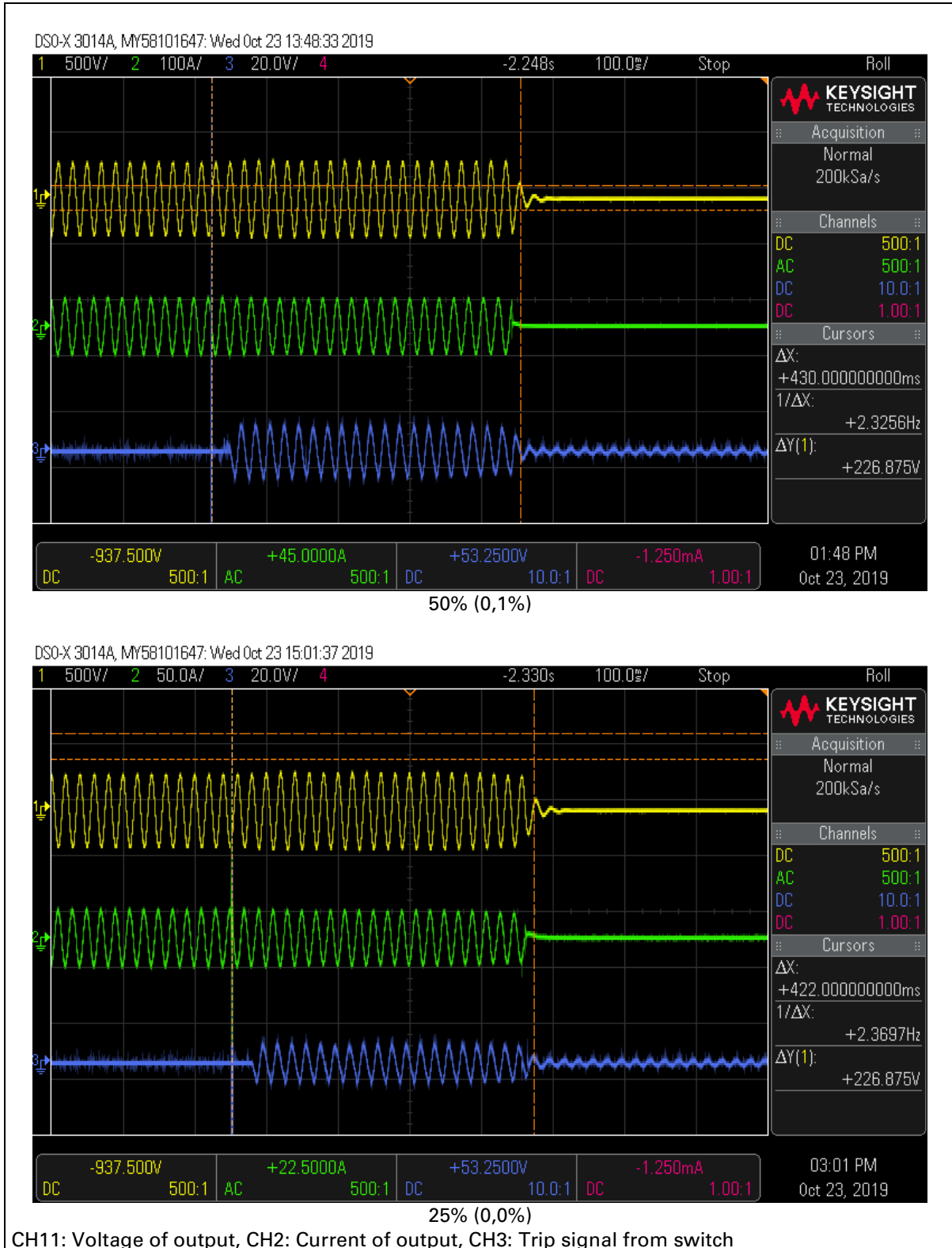

**Appendix Photos**



Overview



Rear view

**Appendix Photos**



Connection Interface



Internal view

--- End of test report---